



# ROW MULCHERS

Side Discharge Spreader for Growers

BERRIES VINEYARDS ORCHARDS NURSERIES

## High-Efficiency Mulch Application



[RowMulchers.com](http://RowMulchers.com)





# ROW MULCHER

Side Discharge Spreader for Growers

[RowMulchers.com](http://RowMulchers.com)

## No equal for the work it does

Millcreek created the popular Row Mulcher when a small blueberry grower asked us to build a spreader for applying wood chips to those acid-loving plants.

Now all kinds of growers have discovered how the original Row Mulcher makes it so practical to apply mulch and compost for moisture conservation, weed suppression, soil temperature moderation and for adding organic material to the soil.



*Model 706 shown*

## Versatile. Rugged. Dependable.

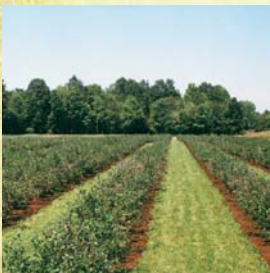

### Berry Crop Farms

Blueberries love wood chip mulch to support the acidic soil conditions they thrive on.



### Vineyards

Mulch helps retain precious soil moisture, keeps soil temperatures buffered against extremes and adds organic matter.



### Orchards / Citrus

Compost and mulch created by tree and fruit residue can be recycled by applying it back to the soil under the drip line.



### Nurseries

Row Mulchers apply material to field grown stock, pot in pot stock and can even serve as a potting soil conveyance system in some cases.





## What a job!

Mulching is one of the most cost effective techniques for retaining soil moisture, buffering soil against extreme conditions and adding organic matter. A Millcreek Row Mulcher makes it a one man job.



## Many sizes



## A robust side discharge spreader for just about any application

Millcreek Row Mulchers are side discharge spreaders engineered and built for small scale and large scale growers.

We understand that specialized equipment has to pay for itself. It's got to be versatile, hold up to rough handling and durable enough to get a very solid return on that investment.

## Many options



That's what you get with a Millcreek Row Mulcher, one of the oldest and most trusted manufacturers of side discharge spreaders in North America - and beyond.

In fact many Millcreek Row Mulchers are used in places like Australia, South Africa, Europe, Asia and South America. It seems that growers are constantly finding new uses for this exceptional labor saving equipment.



# UNSURPASSED VERSATILITY

Wood chips  
Composted chips  
Compost  
Soiless mixes  
Sawdust

Sand peat mixes  
Mushroom soil  
Topsoil mixes  
More



## Mulch Spreading

For applying material in hills, or mounded berms, directly at the base of plants like blueberries.



## Drop Spreading

For applications between rows the operator removes the side conveyor and material drops at the front between the wheels.



## Side Spreading

For spreading in aisles or in drip lines for small trees.

## Shape the application how you want it



The Millcreek Row Mulcher lets you easily make the necessary adjustments to handle various kinds of material, plus conditions such as particle size, moisture content, and material consistency from load to load.

DIRECTIONAL FINS



Width from **12" to 96"**

Depth from **1/2" to 8"**





### Dual Direction Discharge

An option that can reduce trips over the same wheel tracks, reduce aisle turns and speed application.

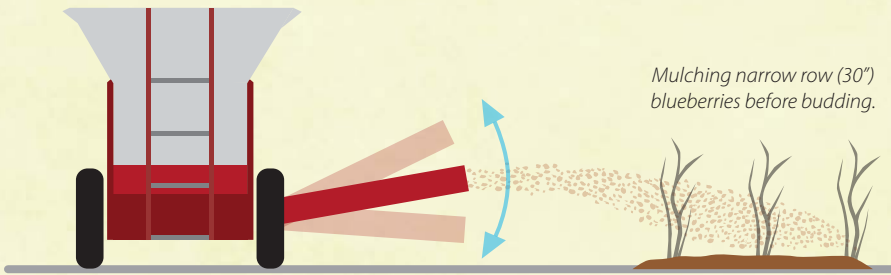

### Distance Spreading

The optional Conveyor Extension adds 5' to 6' reach, adjustable angle allows spreading 20' to 25' feet away depending on material and wind conditions.



Filling nursery containers and similar high production applications

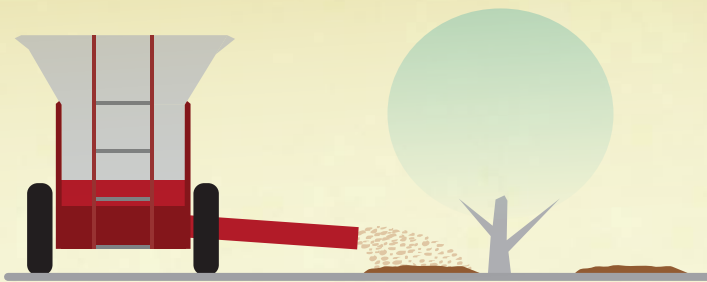

### Remote Spreading

Another technique for orchards, reaching under branches.



On YouTube enter "Millcreek Row Mulcher Extension Conveyor"

## Optional Body Types



**WIDE BODY**  
For high capacity production  
**85"** overall width  
**10,500** pound payload capacity



# A Nursery Workhorse



“ We simply could not be as productive without the Millcreek Row Mulcher. The pot filler attachment has saved us more labor than we can actually calculate. Now our workers can move on to other jobs. Our whole operation is more efficient.

DAVE RESSLER, PRESIDENT, CHERRY LAKE TREE FARMS

## Large Containers

Growers often use containers for growing trees, even large ones. Advantages include easier handling, no tree spade, more control over soil moisture and fertility, simpler shipping and better cost control.

For filling large containers with growing medium the Millcreek Row Mulcher is a valuable labor saving tool. It's also perfect for mulching field grown stock.

[RowMulchers.com](http://RowMulchers.com)

## Pot Filler Attachment

The optional Pot Filler attachment fills large nursery containers quickly and accurately. The Row Mulcher stops at each pot, fills, and moves on. Operators learn quickly how to fill pots without spilling potting mix.

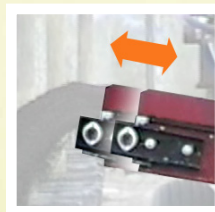

Pot Filler telescopes for fast, accurate filling, maximum material usage.





## Works with the equipment you already have

Millcreek Row Mulchers are hydraulically operated. Hydraulic power can be supplied by the tractor if it's so equipped. Or the tractor PTO drives the available on-board Row Mulcher hydraulic system. Your choice.

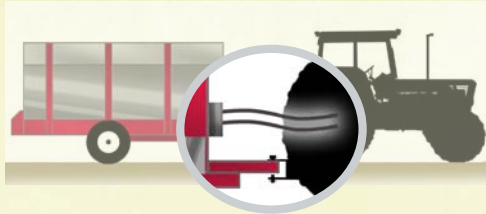

TRACTOR HYDRAULICS

### TRACTOR HYDRAULICS

Hydraulic power to the Row Mulcher is supplied by the tractor's built in hydraulic system.

OR

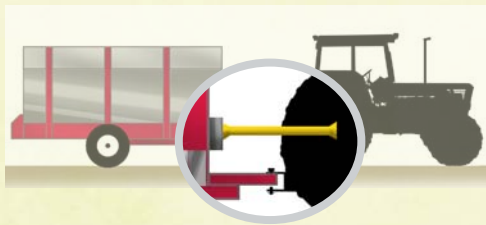

PTO HYDRAULICS

### PTO HYDRAULICS

The tractor PTO powers a hydraulic system built into the Row Mulcher.



## Industry's Best Warranty

The Millcreek Warranty protects you against material or mechanical failure due to workmanship on all mechanical parts for

two years. \* Standard poly floor guaranteed against rust, rot, corrosion or other material failure for the lifetime of your Millcreek Row Mulcher.

*\* Does not include user failure to follow directions, equipment abuse or damage due to accident.*



RowMulchers.com

## 300 Cubic Yards: How Much Labor?



**MANUAL CREW** 58 man hours

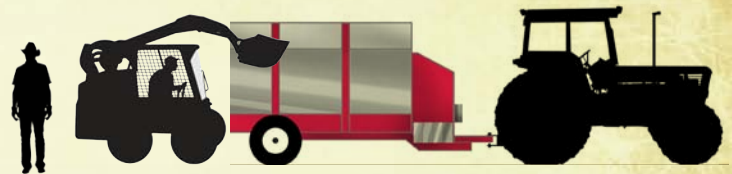

**MILLCREEK ROW MULCHER** 14 man hours





# ROW MULCHER

Side Discharge Spreader for Growers



## MINI Model 204

The narrow body Row Mulcher is designed for use in narrow rows, ideal on hobby farms and estates with cultivated fruit or vegetable crops.

### DIMENSIONS

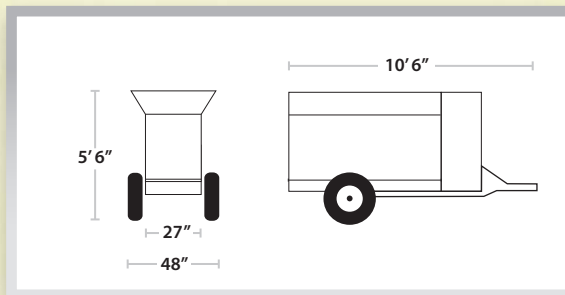

- Product width 48"
- Narrow body Row Mulcher
- All standard Row Mulcher features
- Hydraulics operate from tractor
- Millcreek Warranty

[RowMulchers.com](http://RowMulchers.com)



Model 406 shown





# ROW MULCHER

Side Discharge Spreader for Growers

## COMPACT Model 304

Perfectly sized for operations with up to 20 acres in annual cultivation, and where equipment versatility and long service life are critical to profitability.



### DIMENSIONS

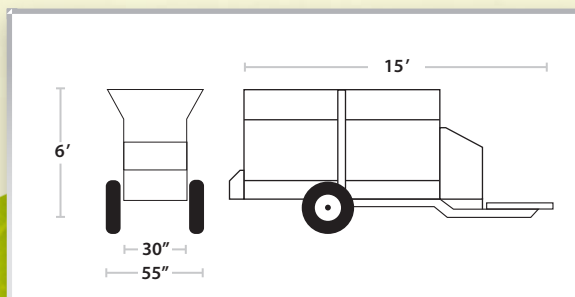

- Product width 55"
- Production scale Row Mulcher
- All standard Row Mulcher features
- Hydraulics operate from tractor
- Millcreek Warranty

[RowMulchers.com](http://RowMulchers.com)

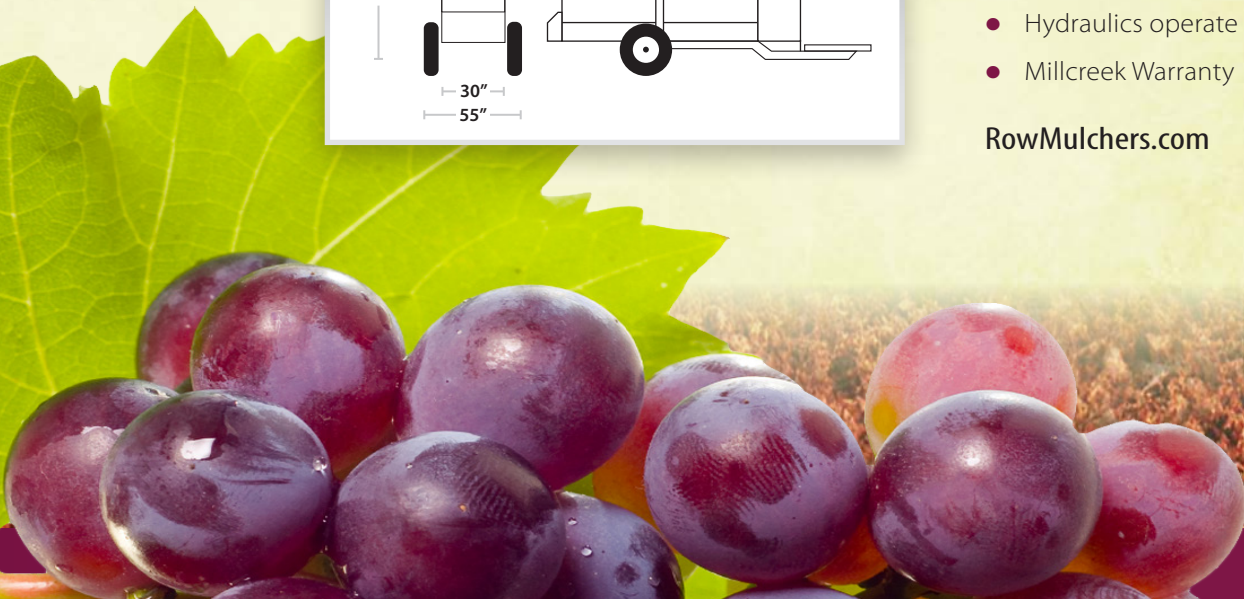





# ROW MULCHER

Side Discharge Spreader for Growers

## STANDARD Models 406, 506, 606, 706

Standard models vary by capacity and dimension. See specifications for details.

Engineered for high production growers, Standard Millcreek Row Mulchers save labor and make it practical to use organic mulches for water conservation, weed suppression and for moderating soil temperatures.



Model 506 shown

## DIMENSIONS

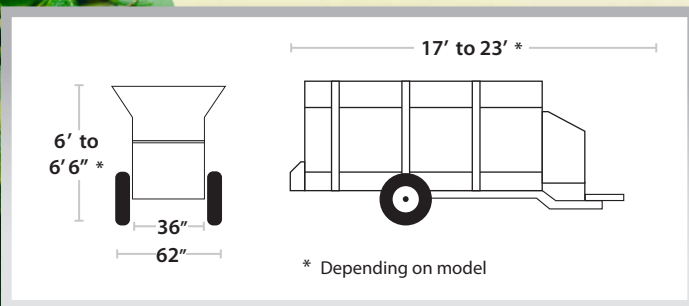

- Product series width 62"
- High production for 50+ acres
- All standard Row Mulcher features
- Hydraulic controls operated from tractor
- Millcreek Warranty

[RowMulchers.com](http://RowMulchers.com)



# FEATURES AND OPTIONS

Photos represent a selection of Features and Options. Not all are shown.



## Discharge control

The Deflector Fins allow the finest degree of control on the shape of the application.



## Cleated belt traction

Material does not slip and slide on the side conveyor's high profile texture.



## Swivel hitch

This clever feature reduces wear and tear on the frame and body during travel.



## Available PTO

There is a wide range of drive train options with a Millcreek Row Mulcher.

[RowMulchers.com](http://RowMulchers.com)

## AVAILABLE ON ALL STANDARD MODELS

Extension Conveyor      Narrow Top Orchard Model  
Dual-Direction Discharge      Custom Frame Configurations

## STANDARD FEATURES

- 11-gauge, galvanized steel body on heavy gauge steel channel chassis
- Galvanized sides; industrial powder coat on chassis and frame
- Heavy-Duty Drive System
- Hydraulic Drive Variable Speed Conveyor up to 26.2 ft./min.
- Airplane Tires are oversized, ideal for heavier loads
- Swivel Hitch for minimizing stress on hitch and chassis on uneven terrain
- Crescent Belt Cross Conveyor for smooth and continuous material flow
- No-rust, no-rot polyethylene plastic lumber floor, lifetime warranty
- Adjustable Discharge Deflectors for precise control of spread pattern and width
- Apron Conveyor Chain #662x pintle, #667x pintle

## OPTIONS

- Dual discharge adds application efficiency with spreading capability from both sides
- Tractor Hydraulic Drive
- PTO Hydraulic Drive
- PTO Mechanical Drive
- Orchard sides (straight)
- Pot filler model
- Electric Discharge Deflector controls for from-the-seat control of spread pattern and width
- Walking Beam Suspension absorbs bumps on uneven terrain, reducing body wear and tear
- Cleated Belt Cross Conveyor helps assist in wider spread pattern and breaks up clumpy material
- Metering Gate gives additional control over amount of material flow to Cross Conveyor





# ROW MULCHER SPECIFICATIONS

Model	MINI	COMPACT	STANDARD				WIDE BODY	
	204	304	406	506	606	706	588	1028
Yards Capacity, Struck	2.1	3.3	4.0	5.0	6.0	7.0	5.8	10.2
Yards Capacity, Heaped	2.9	4.4	5.4	6.7	8.0	9.3	7.8	13.5
Lbs Maximum Payload	2,500	3,000	4,000	4,200	7,000	7,800	6,000	10,500
Overall Width	48"	55"	62"	62"	62"	62"	85"	85"
Overall Length	10' 6"	15'	17'	19'	21'	23'	17'	23'
Loading Height	5' 5"	6'	6'	6'	6' 6"	6' 6"	6' 6"	6' 10"
Body Width	27"	30"	36"	36"	36"	36"	54"	54"
Lbs Weight	1,050	2,100	2,500	2,700	3,300	3,500	3,200	4,200
Apron Chain	T-Rod	#662 Pintle	#662 Pintle	#667 Pintle	#667 Pintle	#667 Pintle	#667 Pintle	#667 Pintle
"Minimum GPM For Tractor Hyd Drive"	5	8	14	14	14	14	14	PTO Only
"Minimum Tractor Hp Required"	18*	25*	30*	30*	50*	50*	40*	80*

\* Follow tractor manufacturer's specifications for towing and weight limits. Most models available in either tractor or PTO hydraulic drive.

## MULCH APPLICATION GUIDE

To determine cubic yards per acre, measure the mulch depth in inches. From the row spacing column and mulch depth, determine the cubic yards per acre **per one foot of mulch width**. For widths other than one foot wide, use a multiplier.

**Example #1:** At 8 foot row spacing and with a mulch depth of 4 inches and one foot wide, chart shows a rate of 67.6 cubic yards per acre. If the desired mulch application width is 3 feet wide, multiply 67.6 cubic yards by 3 for 202.8 cubic yards per acre.

**Example #2:** If the row spacing is 20 feet and the mulch is 2 inches deep, the rate would be 27 cubic yards (at 10 ft.) divided by 2, or 13.5 cubic yards per acre.

RowMulchers.com

Row Spacing (Feet)

Mulch Depth	7'	8'	9'	10'	11'	12'
9.7	9.7	8.5	7.5	6.8	6.2	5.7
1.0"	19.3	16.9	15.0	13.5	12.3	11.3
1.5"	29.0	25.4	22.5	20.3	18.5	17.0
2.0"	38.6	33.8	30.0	27.0	24.6	22.6
4.0"	77.2	67.6	60.0	54.0	49.2	45.2
6.0"	116	102	90.0	81.0	73.8	67.8
8.0"	154	135	120	108	98.4	90.4
10.0"	193	169	150	135	123	113

CUBIC YARDS PER ACRE

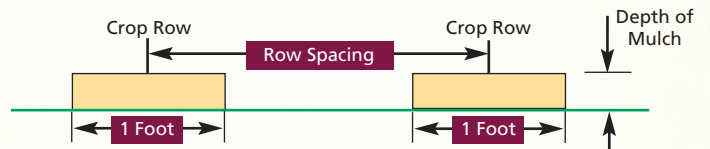

525 Reservoir Road  
Honey Brook, PA 19344

1-800-311-1323

www.rowmulchers.com or www.millcreekmfg.com  
email us at salesinfo@millcreekmfg.com